



# YAMAHA®

## LICENSED PRODUCT



# YAMAHA

## LICENSED PRODUCT

Yamaha, the Crossed Tuning Fork Design, and any likeness thereof are trademarks of Yamaha Motor Corp. U.S.A. and Yamaha Motor Co., Ltd. ("Yamaha") used under license by Sport Dimension Inc. [www.yamaha-motor.com](http://www.yamaha-motor.com).

This Product is not manufactured by Yamaha. For consumer purposes, please contact Sport Dimension Inc. at 1-800-678-7873.

# 500LI / 350LI / 220LI

## EN USER MANUAL

- When passing on this device, include the user manual and all relevant warning information and parts.
- It is the responsibility of the owner to give proper instruction and precaution (regarding the risk associated with this device) when lending the device to other people.

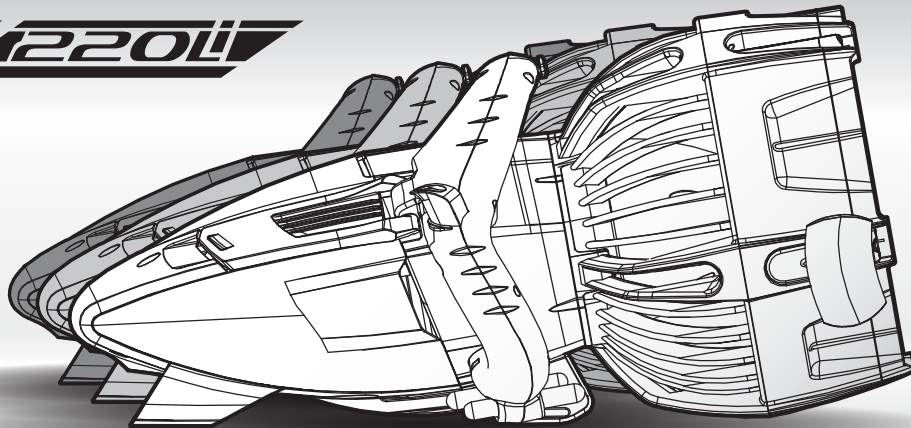

## CAUTION

ELECTRICALLY OPERATED PRODUCT

Not recommended for children under 16 years of age. As with all electrical products, precautions should be observed during handling to reduce the risk of electric shock.



# CONTENTS

INTRODUCTION .....	2
WARNING .....	3
PARTS DIAGRAM .....	5
BATTERY CAUTION .....	6
CHARGING THE BATTERY .....	7
REPLACING THE BATTERY .....	8-9
GETTING STARTED .....	10-11
CARE & MAINTENANCE .....	12
BUYING PARTS .....	12
TROUBLESHOOTING .....	13-14
- Unit does not function	
- Blocked propeller	
- Flooding events	
- Blocked triggers	
CAMERA ASSEMBLY .....	15
TECHNICAL SPECIFICATIONS .....	16
WARRANTY & CUSTOMER SERVICE .....	17-18



Discarded electrical appliances are recyclable and should not be discarded in the domestic waste! Please actively support us in conserving resources and protecting the environment by returning this appliance to the collection centers (if available).



# INTRODUCTION

## | DISCOVER |

There is nothing ordinary about the way it looks....

Or the way it glides for that matter.....

You submerge and it reacts and adapts.....

You toggle into gear, it comes to life....

## THE YAMAHA PROFESSIONAL DIVE LI SERIES!



The Seascooter introduces the first LI-ION battery system in a lightweight recreational DPV that can be charged inside the unit, but that is also removable for external charging and simple battery replacements required for back-to-back dives or snorkel runs.

## | OTHER FEATURES |

### BUOYANCY

The Seascooter contains a self-filling ballast hull to achieve neutral buoyancy almost instantly in seawater. Strategically placed drain holes allow water to freely enter and exit the ballast space making the Seascooter assume neutral buoyancy when submerged, and expel it as soon as it hits the surface.

**! The Seascooter is designed for use in seawater. It will have less buoyancy in fresh water and pool and may sink in such waters.**

### FINS

The strategically placed front foil and pectoral glide fins prevent upward skidding of the Seascooter when accelerating and allow for the fastest straight-line forward navigation underwater. The fins allow you to rest your arms while you use the Seascooter in the water.

### HANDLEBAR + LED BATTERY STATUS INDICATOR

The handlebar of the Seascooter is the user's main navigation tool and is made of the best impact resistant material. It features smart ergonomically positioned triggers for a natural thumb position during trigger operation, accessory D-ring attachment points and a dashboard-style LED battery status indicator for an accurate voltage display during use.

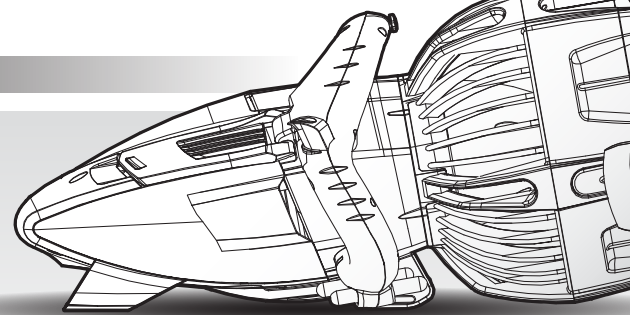



# WARNING



- This is not a life saving device. DO NOT use it as a buoyancy aid.



- ALWAYS inspect the swimming area to ensure it is free of hazards or obstacles such as boats or swimmers before using the Seascooter.



- A child under 16 years old should never operate this product.
- The Seascooter is designed for 1 person use.



- Read the user manual carefully before using this product.



- Be careful when you are transporting the Seascooter and setting it down to avoid crushing hazard on hands, foot or toes.



- Crushing / Cutting Hazard



- Do not attach your body, clothing, other equipment to the seascooter in any way.

- Use appropriate equipment such as wetsuit, BCD, fins, mask & snorkel, surface signaling devise, regulator(s) approved life jacket etc. when using Seascooter.
- The Seascooter shall not be used in reverse direction.
- Only operate the Seascooter in water.
- Adequate lighting shall be used when using the Seascooter in dark waters and during night diving.



- ALWAYS wear a life vest (personal floatation device - PFD) approved by your local authorities for Snorkeling: (U.S. Coast Guard Type III vest in the US or Canadian Coast Guard approved life vest in Canada or SAI Approval PFD in Australia or ISO/CE Approved PFD in Europe).



- Never stick body parts, clothing or other objects in the vicinity of the propeller. Do not wear loose or flowing clothing or equipment that could be drawn into the propeller.



- Particular care should be exercised when using the Seascooter near anybody with long hair. Users with long hair should tie it up or wear a swimming cap when using the Seascooter.



- Be aware of appropriate water levels, tidal changes, dangerous currents, weather change and strong offshore winds. ALWAYS scout unfamiliar water before venturing out.



- Always ensure sufficient charge remains in the battery to return to the shore surface before using the Seascooter.



- Do not use alcohol or drugs prior to and during use of this product.



## **CRUSHING HAZARD:**

The following action during assembly, disassembly, and transportation of the seascooter may incur crushing hazards to your fingers or toes:

- Closing the nose cone latches
- Putting on the nose cone housing
- Setting down the seascooter or battery
- Accidental dropping of the seascooter or battery.

## **CAUTION:**

- NEVER remove the grilles except for maintenance.
- Familiarize yourself with the Seascooter functions and battery life before embarking on any dives or excursions.
- Always charge battery to its fullest before using the Seascooter.
- Do not allow sun tan oils or lotions to be in prolonged contact with the Seascooter plastic as it may cause the plastic to become brittle and break apart.
- If the propeller becomes intermittent, and/or a buzzer is heard, water has entered the housing(s). If safe to do so, turn OFF the master switch, remove the Seascooter from the water and check it for water ingress. ALWAYS observe safe diving practice if this occurs during a dive.
- ALWAYS keep the Seascooter out of direct sunlight when not in use. HEAT KILLS BATTERIES AND IT MAY EXPLODE OR LEAK.
- Never open the Nose Cone of the Seascooter in the water.
- When not in use, always turn the Master Switch to the OFF position.
- Do not use the Seascooter 500Li and 350Li below the recommended maximum depth of 40m/130ft.
- Do not use the Seascooter 220Li below the recommended maximum depth of 30m/100ft.
- This machine is not intended for mixing or working with sand, concrete and material with similar physical characteristics. This machine is only intended for swimming and diving in the water.
- Do not use the unit if it is damaged in any way.
- Replace the battery immediately if it is damaged.
- The Seascooter should only be used for scuba diving by qualified divers.
- When using the Seascooter for scuba diving, ascents and descents should be made in accordance with recognized diving practices.
- Due to safety considerations those who have not obtained a C-Card (attesting to completion of training) from an entity providing diving instruction must not under any circumstances use this product for diving.
- In different waters (seawater, lake, pool) and conditions such as currents, temperature and pressure can affect the buoyancy of the unit which may cause the unit to sink if accidentally released.
- DO NOT release or leave the Seascooter in the water. Always take the unit out of water when not in use.

# PARTS DIAGRAM

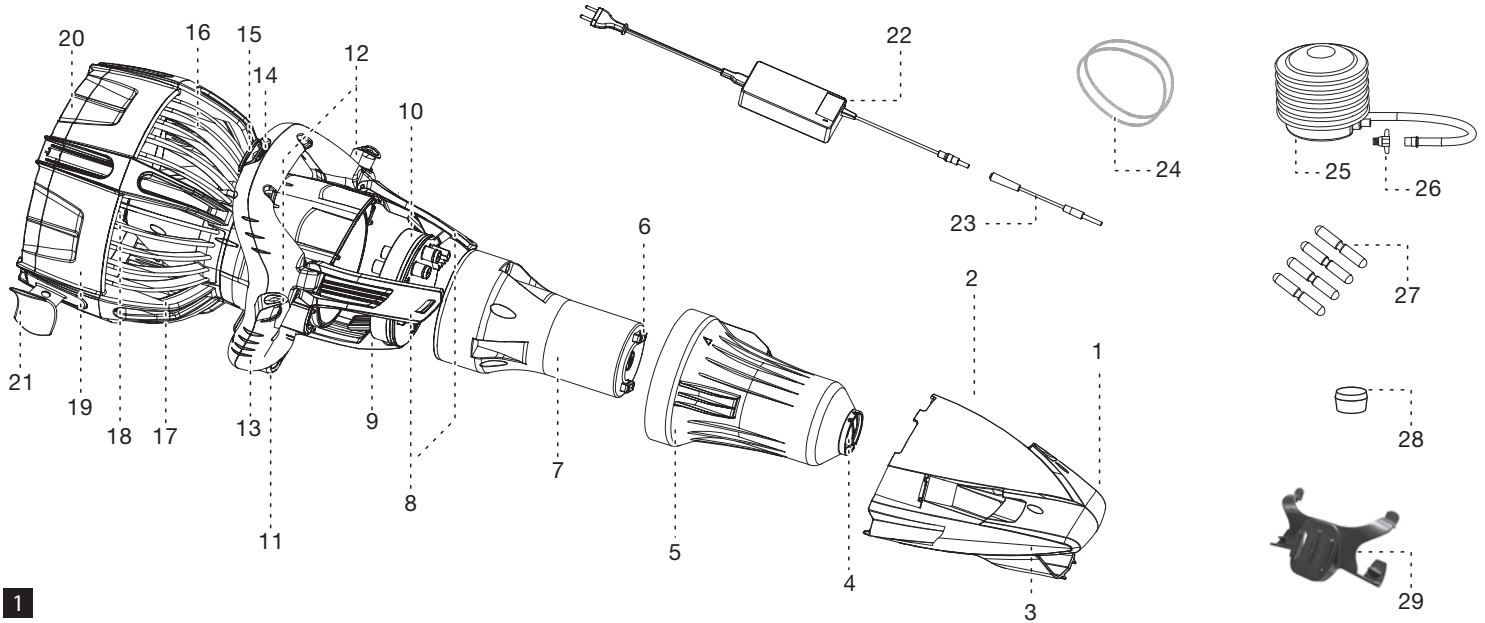

1

- |                             |  |   |  |
|-----------------------------|--|---|--|
| 1 Outer Nose Cone Protector | 9 Base Latch                                   | 17 Nozzle Support                       | 25 Pump  |
| 2 Outer Nose Cone           | 10 PCB (Printed Circuit Board)<br>Box Assembly | 18 Propeller                            | 26 Pump Nozzle                                     |
| 3 Front Foil                | 11 Rear Foil                                   | 19 Nozzle                               | 27 Ballast weight x 4<br>(NOT included with 220Li) |
| 4 Vent Plug                 | 12 Triggers                                    | 20 Rear Grille                          | 28 Silicone Grease                                 |
| 5 Inner Nose Cone           | 13 Handle                                      | 21 Fin x 2<br>(NOT included with 220Li) | 29 Camera Mount                                    |
| 6 Battery Pod Handle        | 14 LED Battery Status Indicator                | 22 Charger                              |  |
| 7 Battery Pod               | 15 Master Switch                               | 23 Extended Charging Cable              |  |
| 8 Side Latches              | 16 Front Grille                                | 24 Rubber Ring x 2                      |  |

# BATTERY CAUTION



**500Li** Battery: Suitable for use in the 500Li / 350Li / 220Li Seascooter

**350Li** Battery: Only suitable for use in the 350Li / 220Li Seascooter

**220Li** Battery: Only suitable for use in the 220Li Seascooter

((See page 12))

## **WARNING!**

Replace the battery immediately if it is damaged.

- Use the specified charger only.
- Must be disposed of properly.
- Always store the battery in well ventilated areas where it is out of the reach of children and away from heat and ignition sources.
- Do not incinerate, disassemble, damage, short-circuit or expose to heat.
- The battery contains safety and protection devices which, if damaged, may cause the battery to generate heat, rupture or ignite.
- Do not place the battery in fire, direct sunlight or apply heat to the battery; it may explode or leak.
- Do not leave the battery in direct sunlight or use or store the battery inside high temperature containers. Doing so may cause the battery to generate heat, rupture, or ignite. Using the battery in this manner may also result in a loss of performance and a shortened life expectancy.
- Do not place the battery on or near fires, stoves, or other high temperature locations.
- **DO NOT THROW WATER ON A BURNING LI-ION BATTERY.** If an exposed battery does ignite, it will burn even more violently if it comes into contact with water or even the moisture in air. A fire extinguisher must be used.
- Do not expose the battery to water or salt water, or allow the battery to get wet.
- Do not subject the battery to strong impacts or shocks.
- Do not pierce the battery with nails, strike the battery with a hammer, step on the battery, or otherwise damage the outer casing.
- **MUST re-charge the battery after EACH USE.**
- **MUST re-charge the battery at least EVERY SIX MONTHS** when not in use.
- **ALWAYS REMOVE** the Battery from the seascooter **FOR STORAGE.**
- Never leave Lithium-Ion batteries discharged for long - the batteries do self-discharge and the charge could drop low enough to damage the battery.
- Keep Lithium-Ion batteries away from high heat - high temperatures may cause premature battery failure.
- **ALWAYS** store Lithium-Ion batteries partially discharged in a cool, dry place.



### **WARNING** BATTERY SAFETY

**RE-CHARGE THE BATTERY  
AT LEAST**

# **6 MONTHS**

- **MUST** re-charge the battery after *EACH USE*.
- **MUST** re-charge the battery at least *EVERY SIX MONTHS* when not in use.
- **ALWAYS REMOVE** the Battery from the seascooter *FOR STORAGE*.
  - Never leave Lithium-Ion batteries discharged for long - the batteries do self-discharge and the charge could drop low enough to damage the battery.
- Keep Lithium-Ion batteries away from high heat - high temperatures may cause premature battery failure.
- **ALWAYS** store Lithium-Ion batteries partially discharged in a cool, dry place.



[www.seascooter.net](http://www.seascooter.net)

# CHARGING THE BATTERY



To remove the Nose Cone and charge the Battery Pod, user **MUST** follow these instructions to avoid any injury.

1. ALWAYS ensure that the Master Switch is in OFF position. (see Fig. 2)
2. ALWAYS ensure that the Seascooter is out of the water, dry and placed in a dry area.
3. Pull the three Latches down and remove the outer nose cone (see Fig. 3 & 4)
4. Release the Vent Plug on top of the Nose Cone. (see Fig. 5)
5. Connect the extended charging cable to the charging plug of the charger. (see Fig. 6)
6. Plug the extended charging cable into the battery pod through the vent plug hole and then plug the Charger into the mains (wall socket), and turn on the supply. (see Fig. 7)
7. Charging will take around 3-5 hours for a fully discharged 220Li battery, 4-6 hours for a fully discharged 350Li battery and 7-9 hours for a fully discharged 500Li battery. When the Battery Pod is charging, the LED light of the charger turns RED. When the battery is fully charged, the LED light turns GREEN (see Fig. 8)
8. Once the battery pod is fully charged, unplug the Charger from the mains (wall socket).
9. Unplug the extended charging cable from the battery pod.
10. MAKE SURE the seals and sealing surface are clean and fully lubricated with the supplied grease EVERYTIME (you can also buy this at your local hardware store) before replacing the vent Plug (see Fig. 9 & Fig. 10) and CLOSE THE VENT PLUG TIGHTLY. (see Fig. 11). MAKE SURE the plastic link of the vent plug is not jammed in between the vent plug and the o-ring when tighten the vent plug.
11. Close the outer nose cone with the 3 latches.

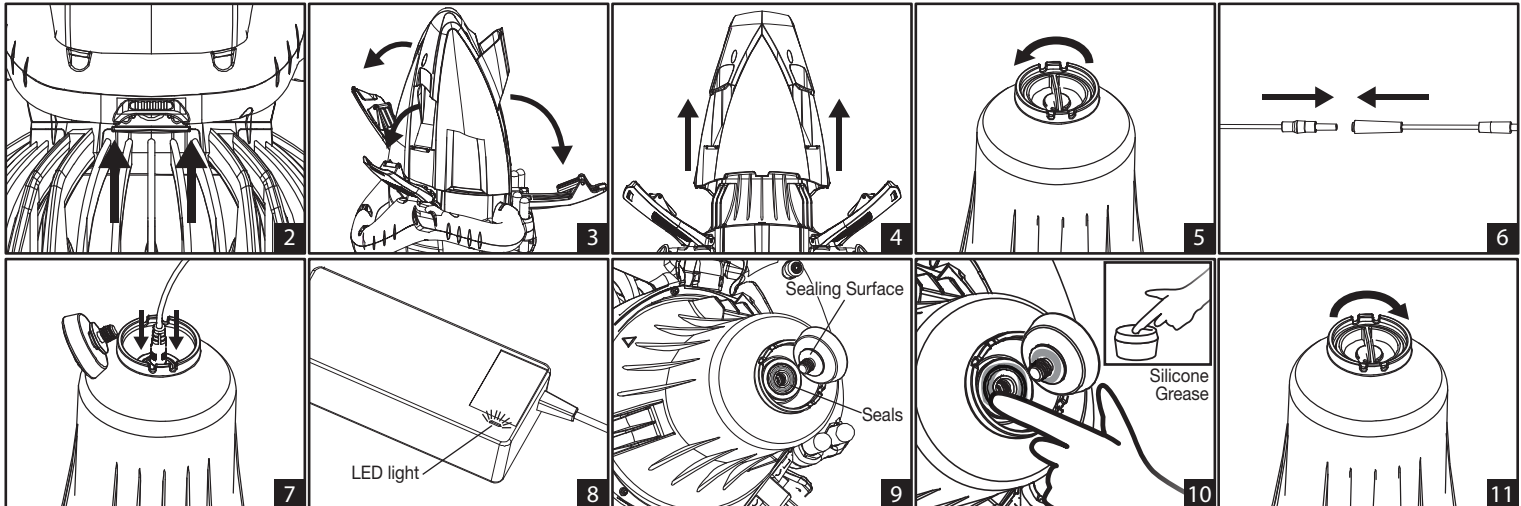



# REPLACING THE BATTERY



To remove the Inner Nose Cone and replace the Battery Pod, user **MUST** follow these instructions to avoid any injury.

1. ALWAYS ensure that the Master Switch is in OFF position. (see Fig. 12)
2. ALWAYS ensure that the Seascooter is out of the water, dry and placed in a dry area.
3. Pull the three Latches down and remove the outer nose cone. (see Fig. 13 & 14)
4. Release the Vent plug on top of the Nose Cone. (see Fig. 15)
5. Tie up the rubber rings together and pull them through the slots of the inner nose cone and attach both ends around the handle and bottom latch hinge as shown in Fig. 16.
6. Remove the pump nozzle from the pump, and screw it to the vent chamber.
7. Connect the pump to the Pump nozzle and pump air in until the Nose Cone pops off (see Fig. 17).

**IMPORTANT:** ALWAYS attach the Rubber Ring before using the pump. The Nose Cone can pop off and cause injury if the Rubber Ring is not attached and tightly secured.)

8. Remove the Rubber Ring and the Inner Nose Cone. (see Fig. 18)
9. Take out the Battery Pod from the unit. (see Fig. 19)
10. Replace with a new suitable battery pod.

**IMPORTANT:** 500Li battery pod is suitable for use in the 500Li, 350Li and 220Li Seascooter. 350Li battery pod is only suitable for use in the 350Li & 220Li Seascooter. 220Li Battery pod is only suitable for use in 220Li Seascooter. (see page 12)

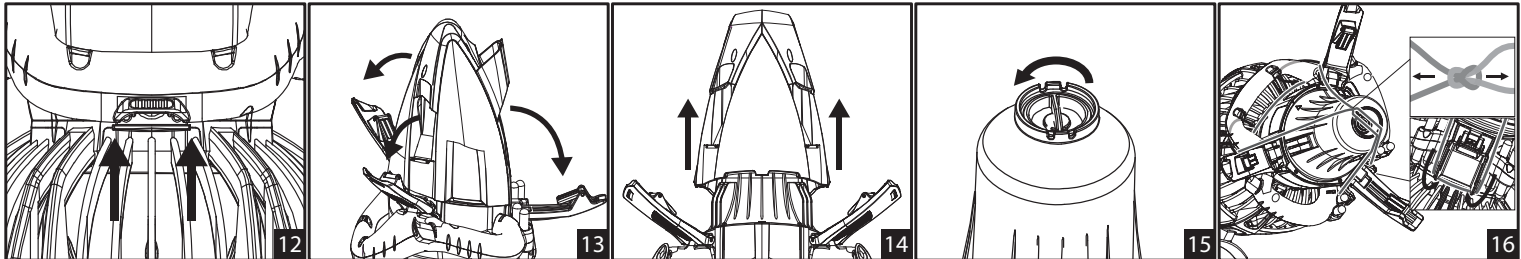

11. **MAKE SURE** the seals and sealing surface are clean and Fully lubricated with the supplied grease **EVERYTIME** (you can also buy this at your local hardware store) before replacing the Inner Nose Cone. (see Fig. 20 and 21)
12. Align the arrow marking and close the inner nose cone by pushing all the way down. (see Fig. 22)
13. **MAKE SURE** the seals and sealing surface are clean and lubricated before replacing the vent Plug and **CLOSE THE VENT PLUG TIGHTLY**. **MAKE SURE** the plastic link of the vent plug is not jammed in between the vent plug and the o-ring when tighten the vent plug.
14. Close the outer nose cone and the three latches.

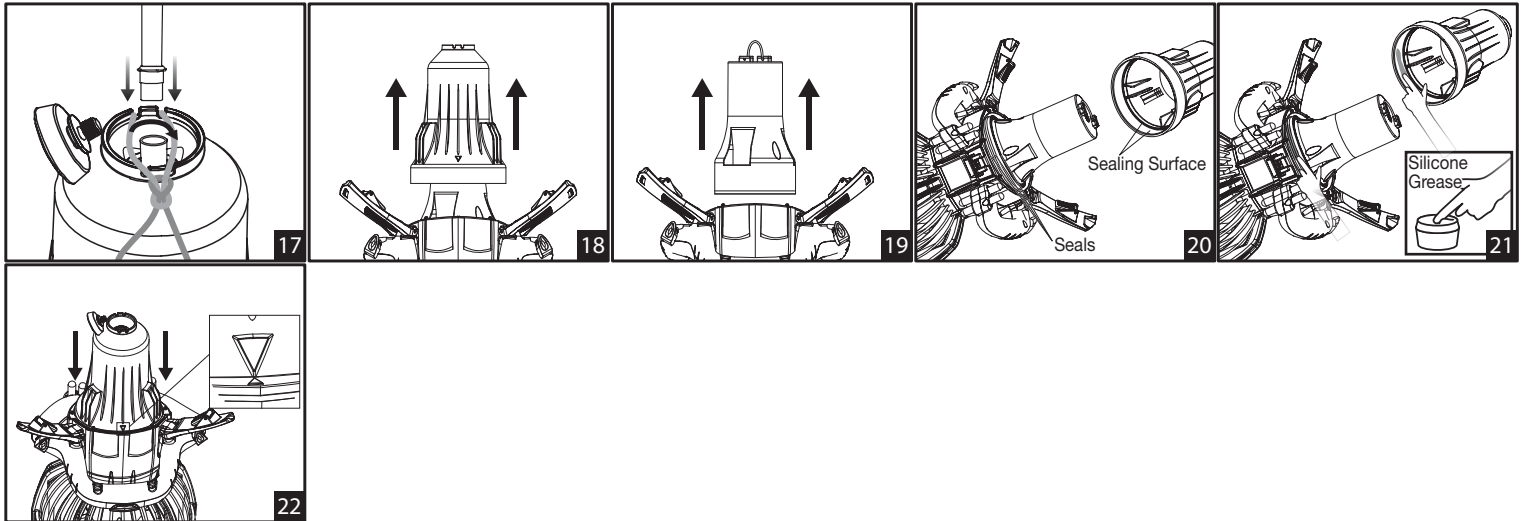

# GETTING STARTED

Before you use the PROFESSIONAL DIVE LI series Seascooter for the first time, the battery needs to be charged. Follow the Battery Cautions on page 6 and Charging instructions on page 7.

Your Seascooter 500Li & 350Li can be used for swimming, snorkeling or diving up to 40m/130ft (by qualified divers).

Your Seascooter 220Li can be used for swimming, snorkeling or diving up to 30m/100ft (by qualified divers).

To use the Seascooter, follow these instructions.

1. Follow instructions on page 7 and charge the battery just before use.
2. Place the Seascooter into the water and rock gently to release trapped air.
3. The Professional Dive Li series unit automatically assumes neutral to positive buoyancy in seawater. It will have less buoyancy in fresh water and pool and may sink in such waters. In fresh water the 500Li unit may assume slight negative buoyancy. The 350Li and 220Li units assume neutral to positive buoyancy. All units will have less buoyancy in fresh water and pool and may sink in such waters. Always check the buoyancy of your unit before use. Use accessory lead ballast weights (Purchase separately for 220Li) for making small buoyancy adjustments (see Fig. 23).
4. Slide both clip-on accessory fins onto the rear grille fixture points of your Professional Dive Li series unit (see Fig. 24, Purchased separately for 220Li).
5. When ready to set off, switch the Master Switch to the ON position (see Fig. 25).
6. **For US version :** The Professional Dive Li series unit can be operated by pushing only one trigger or both triggers at the same time. Push the left or right Trigger to start the Propeller (see Fig. 26). The Seascooter will accelerate up to speed 1. (There is a short delay before the Propeller begins to rotate)  
**For EU version :** Push both Triggers to start the Propeller (see fig. 26). The Seascooter will accelerate up to speed 1. (There is a short delay before the Propeller begins to rotate)
7. **For US version :** To increase speed at any time, simply pulse the left or right trigger off and on again within half a second. The Seascooter will accelerate up to the next speed level.  
**For EU version :** To increase speed at any time, simply pulse the left or right trigger off and on again within half a second. The Seascooter will accelerate up to the next speed level. Make sure to keep both trigger pressed at all times.
8. When at maximum speed, further pulses will have no effect. (500Li & 350Li - 3 speeds, 220Li - 2 speeds)
9. To stop the Propeller, simply release both Triggers.
10. Always set the Master Switch to the OFF position when the Professional Dive Li series unit is out of the water. (see Fig. 27)
11. Maintain proper posture to achieve the maximum speed when using the Seascooter.  
– see Fig. 28 for the correct position of the Seascooter when using it.

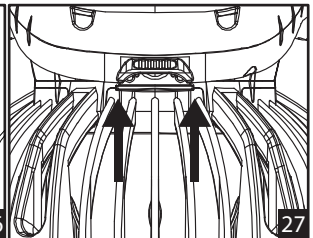
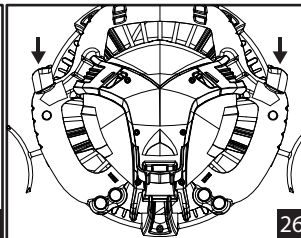
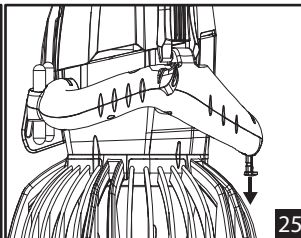
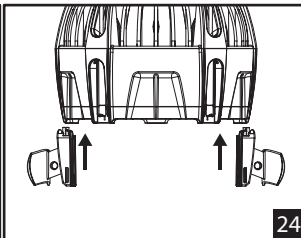
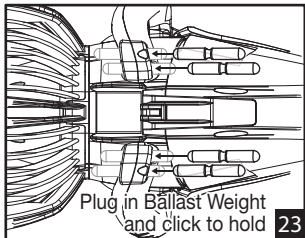

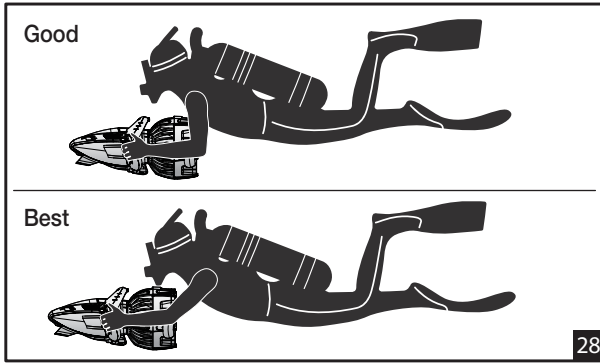

1. User should always try and assume the most horizontal body position for the best performance results. (see Fig. 28)

### LED battery status indicator (operates when Master Switch is on)

Your Seascooter has a Battery Status Indicator (see Fig. 1 “Parts Diagram” - part 15), which can be seen through the LED Window located in the Handle. When the battery is full, 3 green LEDs are on. When 2 LEDs are on, 2/3 of power remains. When 1 LED is on and flashing, about 1/3 of power remains. When all 3 LEDs are off, the machine will run 3 minutes and then will automatically shut down.

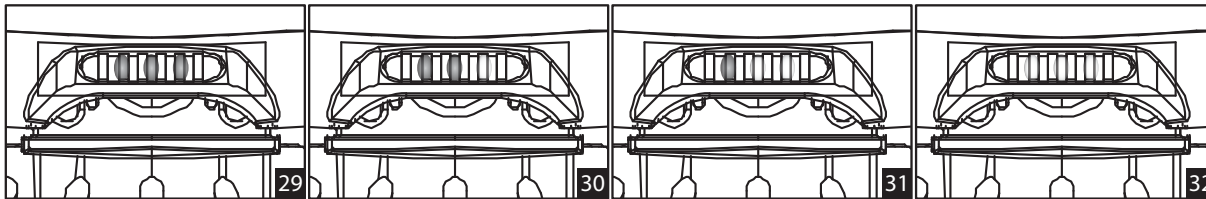

# CARE & MAINTENANCE

## Washing and Care

- DO NOT leave the Seascooter in the water. Always take the unit out of water when not in use.
- Always rinse the Seascooter with fresh water and allow it to dry before storage.
- Whenever possible rinse the Seascooter with fresh water immediately after use.
- To clean the Seascooter do not use detergents; only use a damp cloth to wipe the unit clean.
- The battery housing interior should be kept dry at all times.
- If the battery housing interior gets wet, see page 14, “Flooding Events” for procedure.

# BUYING PARTS

Additional battery pods, chargers or **Li** series accessories can be purchased separately. Please contact your Local Customer Service Center / Distributor, or visit [www.seascooter.net](http://www.seascooter.net) to purchase them.

## Using the Optional Extended Life Battery for 350Li and 220Li

An optional extended life battery is available through your Local Customer Service Center / Distributor (or visit [www.seascooter.net](http://www.seascooter.net)). The battery fits into the Battery housing in the same position as the Normal battery, and can be charged the same way as the standard battery.

Optional Extended Life Battery Running Time (Normal Use)

	500Li	350Li	220Li
500Li battery	90 minutes	120 minutes	160 minutes
350Li battery	NA	75 minutes	100 minutes
220Li battery	NA	NA	60 minutes

## CAUTION:

The Seascooter 350Li and 220Li will assume slight negative buoyancy when using the extended life 500Li Battery, because this battery is heavier than the standard batteries included with the 350Li and 220Li Seascooter. When upgrading your 350Li or 220Li with an 500Li battery pack always insert EPS floats inside the Nose cone as illustrated for adding extra buoyancy. Never use the 350Li or 220Li with 500Li battery pack without adding the EPS Floats because the units will have less buoyancy and may sink. EPS floats can be purchased separately.

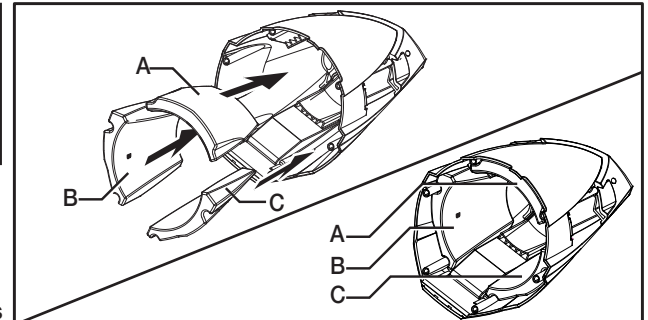

Check the marking on the EPS floats and insert them into the Nose Cone as shown above. Always use 3M double-sided tape to fix the EPS Floats inside the Nose Cone. Never use glue.

# TROUBLESHOOTING

## Unit does not function

If the Propeller does not start when the trigger(s) is/are pressed, make sure:

1. The Master Switch is ON.
2. The Battery Pod is fully charged. (see page 7, Charging The Battery)
3. The battery compartment is dry.

## Blocked Propeller

If the Propeller becomes blocked, it will be necessary to open the Protective Grilles to remove the obstacle.

UNDER NORMAL USE the grilles must not be opened.

NEVER turn the propeller ON when it is blocked; it would cause serious damage to the gear box.

## Opening the Grilles to Remove Obstruction

### WARNING

#### Crushing / Cutting Hazard

Before opening the grille for maintenance purposes, make sure the master switch is in off position, and the battery is disconnected.

1. Take the Seascooter out from the water.
2. Make sure the Master Switch is in the OFF position.
3. Disconnect and remove the Battery Pod - see page 8, step 1 - 9.
4. Unscrew the five Rear Grille screws to remove the rear grille. (see Fig. 33)
5. While holding the Propeller, use an M6 socket wrench to remove the nut from the Propeller shaft as shown in Fig. 34.
6. Slide the Propeller off the shaft, taking care not to lose the drive pin or washers.
7. Remove the blockage from the Propeller or Propeller Shaft.
8. Replace the drive pin (if removed), see Fig. 35, and Propeller. Turn the Propeller slowly until you locate the pin and push the Propeller fully on.

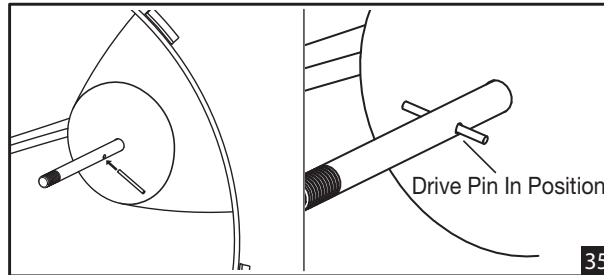
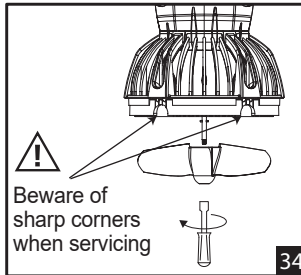
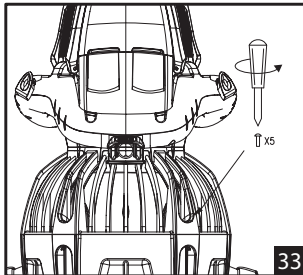

9. Replace the washer and nut and tighten with the socket wrench while holding the Propeller; make sure it is securely fastened. (see Fig. 36)
10. Re-install the rear grille.
11. Install the Battery Pod and replace the Nose Cone when ready for use.

### Sand or Grit on O-ring Seal

Ensure that sand/grit does not get on the seals as correct maintenance and care is essential. To remove sand or grit from the O-ring Seal, rinse the O-ring Seals with fresh water and apply fresh lubricant. If there is sand inside the Battery Housing, gently brush the sand from the unit, taking care not to scratch the sealing surfaces.

If an O-ring Seal is damaged, replace it with a new one and apply fresh lubricant before use.

### Flooding Events

Be sure to keep the O-ring Seal sand and grit free to ensure it keeps water out and to close the latches fully after accessing the battery chamber. However, should the O-ring Seal not be clean or the latches not fully closed and water enters the battery chamber, your Seascooter will not be damaged as it is designed for protection against accidental flooding.

### Water Leakage Sensor (operates when propeller is turning)

Your Seascooter has a built-in water leakage sensor – when the unit experiences accidental flooding, the motor will stop momentarily every 10 seconds. At the same moment, a buzzer will beep every 10 seconds.

### If water enters the battery chamber:

1. Remove the Seascooter from the water if safe to do so. Always observe safe diving practices.
  2. Remove outer and inner nose cone and tip out any excess water.
  3. Remove battery pod.
  4. If salt water has entered, rinse battery, battery pod and housing with fresh water.
  5. Dry housing and battery pod thoroughly.
- If the battery chamber is dry and the water leakage sensor continues to beep, there is a leakage in the motor housing; contact customer service center/repair center for maintenance.

**DO NOT OPERATE A UNIT WITH A SUSPECTED LEAK INTO THE MOTOR CHAMBER.**

### Blocked triggers

If not washed properly, sand, salt or grit build-up could harm the operation trigger mechanism. Please follow below maintenance instruction:

1. Pull out the triggers button and remove the rubber cap located at the bottom of the handle. (See Fig.37)
2. Spray and flush water into the triggers, or the Rubber cap holes to clear any debris. (See Fig.38)
3. Put the Triggers and the Locking Buttons back in position and test if they operate smoothly.
4. **MAKE SURE** to put the Rubber caps back in position before use.

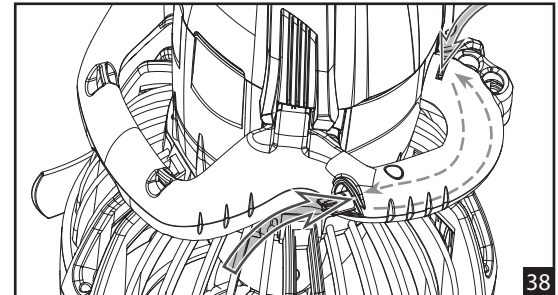
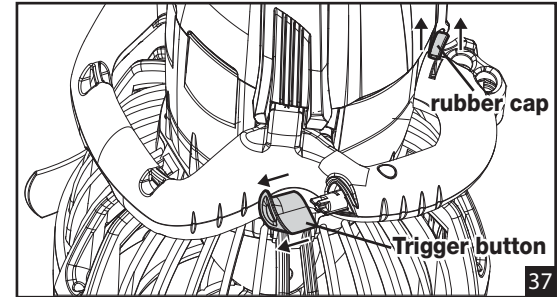
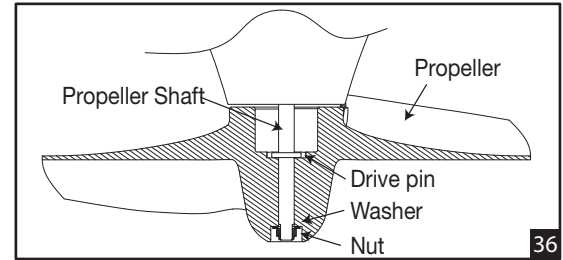

# CAMERA ASSEMBLY

Can be used with GoPro® HERO [3, 3+, 4, or 5] cameras, or other camera with using the same mount system.  
To attach your camera to a mount, firstly you will need a thumb screw or hardware depending on the mount you are using.

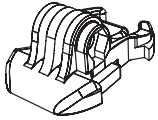

Attachment Buckle

+

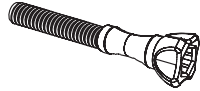

Thumb Screw

+

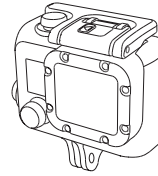

Waterhousing

=

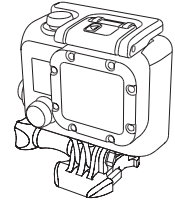

Complete Unit

## ATTACHING YOUR CAMERA TO SEASCOOTER MOUNTS

To attach your camera to the Seascooter, please follow the step below:



Camera Mount

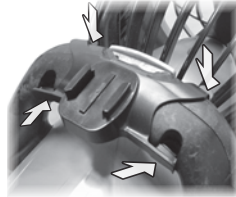

Clip On The Camera Mount  
To The Seascooter Top Handle

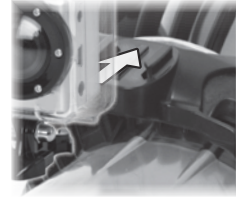

Insert The Buckle  
To The Camera Mount



## REMOVE THE CAMERA MOUNT

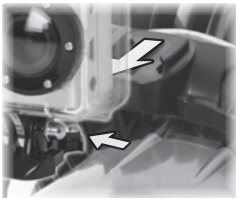

Release  
The Buckle,  
And Take Out  
The Camera

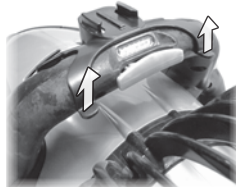

To Remove  
The Camera Mount,  
Simply Lift Up The  
Clips To Release  
The Lock



# TECHNICAL SPECIFICATIONS

## SEASCOOTER™ 500Li

Unit Dimensions	12.6 inches x 11.8 inches x 24 inches (319 x 300 x 610 mm)
Unit Weight	21 lb (9.5 kg) (with rechargeable Li-ion battery)
Battery Type	1 x 22 V / 12000 mAh rechargeable Li-ion battery
Battery Life / Fully Charged	*Runs up to 90 minutes with normal use ( <sup>^</sup> Continuous use up to 30 minutes)
Depth rating (Maximum advised depth rating for recreational diving)	40 m / 130 ft
□Gears / Speed	3 speeds / Up to 4.35 mph (7 km/h)

## SEASCOOTER™ 350Li

Unit Dimensions	12.6 inches x 11.8 inches x 24 inches (319 x 300 x 610 mm)
Unit Weight	19 lb (8.6 kg) (with rechargeable Li-ion battery)
Battery Type	1 x 22 V / 8000 mAh rechargeable Li-ion battery
Battery Life / Fully Charged	*Runs up to 75 minutes with normal use ( <sup>^</sup> Continuous use up to 30 minutes)
Depth rating (Maximum advised depth rating for recreational diving)	40 m / 130 ft
□Gears / Speed	3 speeds / Up to 3.7 mph (6 km/h)

## SEASCOOTER™ 220Li

Unit Dimensions	12.6 inches x 11.8 inches x 24 inches (319 x 300 x 610 mm)
Unit Weight	19 lb (8.6 kg) (with rechargeable Li-ion battery)
Battery Type	1 x 22 V / 4000 mAh rechargeable Li-ion battery
Battery Life / Fully Charged	*Runs up to 60 minutes with normal use ( <sup>^</sup> Continuous use up to 30 minutes)
Depth rating (Maximum advised depth rating for recreational diving)	30 m / 100 ft
□Gears / Speed	2 speeds / Up to 3.1 mph (5 km/h)

### \*Normal Use

The definition of normal use is based on the average general time during which the user activates the Seascooter in the water

### <sup>^</sup>Continuous Use

The definition of continuous use is based on a fully charged battery whereby the Seascooter is used continuously in the water without stopping.

### □Gears / Speed

May vary depending on diver's posture, physique, equipment configuration and water conditions.

# CONSUMER WARRANTY & SERVICE INFORMATION

Distributors in the United States and Canada provide a Standard Limited Warranty for 6 months from the date of purchase for new products. If you're not located in the United States or Canada, please contact your Local Distributor for warranty arrangements in your territory. Please visit [www.seascooter.net](http://www.seascooter.net) for Distributor / Service Center details. Distributors ONLY warrant Yamaha Seascooter products purchased from an authorized dealer and with an original purchase receipt. All warranties are limited to a single original owner on the purchase of new and current product from an authorized reseller. Closeouts, Discontinued and Secondary sales of any kind including "like new" or out of box are not eligible for warranty consideration.

This warranty gives the consumer specific legal rights, and those rights may vary from place to place. Ask your Local Distributor for the warranty period in your region by calling their Service Center. Any part of the product supplied by the Distributor and found in the reasonable judgment of the Distributor to be defective in material or workmanship will be repaired or replaced then returned by the Distributor without charging for parts and repair costs. The product including any defective part must be sent to the Distributor within the warranty period. The customer will pay for the expense of delivering the product to the Distributor.

This warranty does not cover any product that has been subject to misuse negligence or accident, or that has been operated in any way contrary to the operating instructions as specified in the User Manual. Any flood, loss or damage, for any reason, that is caused by accidental release and sinking of the unit, or from flooding an o-ring sealed or water tight area will not be covered under warranty. This warranty does not apply to theft, loss, abuse or tampering, lack of maintenance, improper storage, exposure to excessive temperature, extended sunlight, material interactions, deteriorating chemicals or fumes, any damage to the product that is the result of improper maintenance or parts replacement performed by someone other than the official Distributor Service Center or to any product that has been altered or modified so as to change its intended use. This warranty does not extend to repairs made necessary by normal wear or by the use of parts or accessories which are either incompatible with the product or adversely affects its operation, performance or durability.

## **In addition, this warranty does not cover items that experience normal wear and tear.**

**All implied warranties are limited in the duration to the warranty period. And such implied warranties including merchantability, fitness for a particular purpose, or otherwise, are disclaimed in their entirety after the expiration of the appropriate warranty period. The distributor's obligation under the warranty is strictly and exclusively limited to the repair or replacement of defective parts and return of the product to the customer. The distributor does not assume or authorize anyone to assume for them any other obligation.**

**The distributor assumes no responsibility for incidental, consequential or other damages including, but not limited to expense of returning the product to the distributor, loss of use of product and loss of time or inconvenience.**

**THIS PRODUCT IS DESIGNED AND INTENDED FOR PERSONAL RECREATIONAL USE ONLY!**

**THIS PRODUCT IS NOT WARRANTED FOR COMMERCIAL OR RENTAL USE!**

**REPAIR WORK OR DELIVERY OF A REPLACEMENT DOES NOT EXTEND OR RENEW THE WARRANTY PERIOD.**

**WARRANTY SHALL AUTOMATICALLY BE VOID IF DAMAGE IS RESULT OF NON-ORIGINAL PARTS.**

## LIMITED WARRANTY for seascooters with camera mount:

- ALWAYS inspect to ensure the product works properly every time before use. Warranty of this product does not cover any damages due to misuse.
- Failure to follow the user(s) instructions on packaging and/or user(s) manual may result in damages or loss of your cameras including but not limited to any user's personal items, all of which are not covered under warranty of this product.
- Use at your own risk. Manufacturer(s) and/or suppliers/agents are not responsible for any damages/repairs, loss to cameras/electronic items including but not limited to any user's personal items directly and/or indirectly resulted in the use of this product. Damage(s) resulting from any use, misuse, accident, and normal wear and tear are understandably not covered under this product warranty nor be responsible by manufacturer(s) and/or suppliers/agents.

## EXCLUSIONS

BATTERY. This warranty does not include the battery.

Never replace the original SEASCOOTER BATTERY with an AFTERMARKET BATTERY. Seascooter with aftermarket battery will not be covered by this warranty.

## CUSTOMER ENQUIRIES

If your unit is not operating, please refer to your User Manual before contacting our Customer Service Center. For any damage or repair work required, please do not return your product to the store where it was purchased.

## RETURN / REPAIR POLICY

Customers must contact their Local Distributor Service Center to ask for an official Claim Form. The Claim Form must be returned with the customer's contact details and a photo of the Seascooter, defective parts, the serial number and the Original Purchase Receipt. The Distributor Customer Service Center will review the case and issue a Return / Repair Authorization Number before sending the product to the Distributor Service Center. Returned products must be shipped with original packaging including the polystyrene packing material and all defective parts. Please contact your Local Distributor Service Center for assistance in handling your case.

**Please visit our website [www.yamahaseascooters.com](http://www.yamahaseascooters.com) for a listing of most update distributor contacts and service center contacts.**

## RETURN / REPAIR PROCEDURE

1. Call the Customer Service Center for your Return / Repair Authorization Number.
2. Make a copy of your Proof of Purchase (receipt).
3. Pack the defective unit in its original packaging including the polystyrene foam and include the unit and all defective parts.
4. Attach the copy of your Proof of Purchase (receipt) to the outside of the box (clearly visible), together with the Return / Repair Authorization Number.
5. Ship the package to the Service Center on your cost.

**PLEASE NOTE:** Deliveries that do not have the Proof of Purchase (receipt) and Return / Repair Authorization Number attached clearly to the outside of the box, will not be accepted by the Service Center.

**For any questions or queries you may have regarding your SEASCOOTER™, please follow the below steps for easy and fast resolution:**

- **STEP 1-** Please read your User Manual. For a copy of the User Manuals, please visit [www.yamahaseascooters.com](http://www.yamahaseascooters.com)
- **STEP 2-** Go to [www.yamahaseascooters.com](http://www.yamahaseascooters.com) and see our FAQ section to find instant answers.
- **STEP 3-** Contact one of our Customer Service representatives at the Customer Service Center in your region.

**For more information on Seascooter™ Products**  
(Warranty, Customer Care / Maintenance, Parts & Battery Purchase)

**PLEASE VISIT [www.yamahaseascooters.com](http://www.yamahaseascooters.com)**

All corresponding specification appear in this manual are correct at the time of printing.  
For the latest updates and further information on the complete range of the Seascooter™,  
PLEASE VISIT [www.yamahaseascooters.com](http://www.yamahaseascooters.com)

Yamaha, the Crossed Tuning Fork Design, and any likeness thereof are trademarks of Yamaha Motor Corp. U.S.A. and Yamaha Motor Co.,  
Ltd. ("Yamaha") used under license by Sport Dimension Inc. [www.yamaha-motor.com](http://www.yamaha-motor.com).

This Product is not manufactured by Yamaha. For consumer purposes, please contact Sport Dimension Inc. at 1-800-678-7873.

**(US & CANADA MARKET ONLY)**

Please visit our website at [www.yamahaseascooters.com](http://www.yamahaseascooters.com) to find out your local distributor.

**Products covered by the following patents:**

USA, Canada, EU, Australia, Japan, Hong Kong, China & Turkey  
US D471,506S / US D518,768S / D527,702S / US D506,176S / US D507,776S  
D512,678S / D519,911S / 6848385 B2 / US 7000559 B2 / US 7093554 B1 / 11/102,302  
0500577.8 / 0500578.0 / 0500579.2 / HK1072691 / ZL200530005661.5  
ZL200430079550.4 / ZL200430057359.X / ZL200530005662.X / ZL200530005663.4  
ZL200320103738.8 / ZL200520008894.5 / 1194933 / 1254107 / 1225250  
000330311-0001 / 000183900-0001 / 000183900-0002 / 000330279-0001  
000330295-0001 / 03020902.7 / 302949 / 302564 / 302563 / 302950  
302948 / 2005100230 / 200503474 / 29/268,724 / 11/595,675 / 000816376-0001

**US & CANADA MARKET ONLY**

Toll Free (US) : 1-800-678-7873  
[service@yamahaseascooters.com](mailto:service@yamahaseascooters.com)  
**[www.yamahaseascooters.com](http://www.yamahaseascooters.com)**